

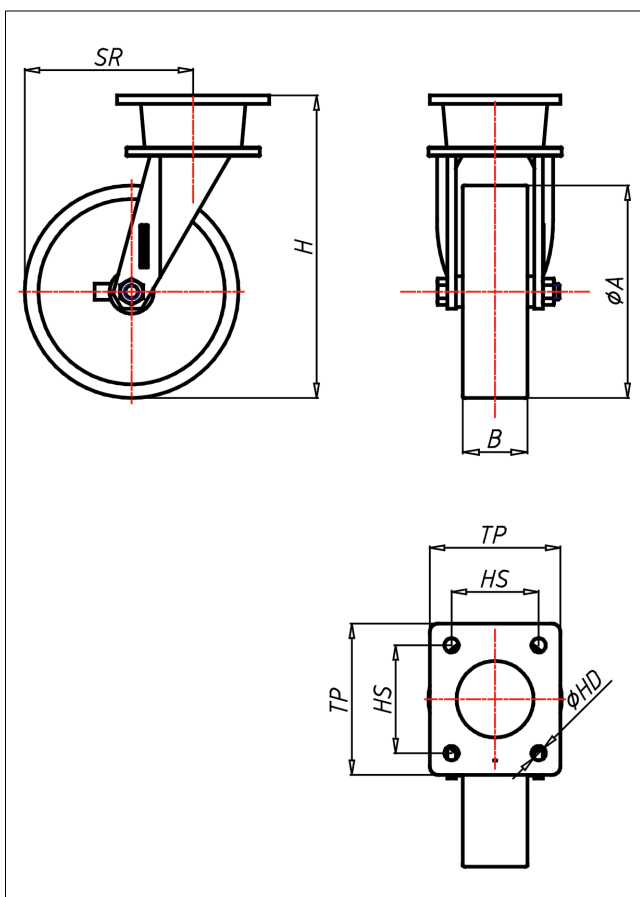

EH-SUTM

Lenkrolle



EH-SU



LENKROLLE	Feststeller TLCH Seite 42	BOCKROLLE																				
<ul style="list-style-type: none"> geräuscharmer Lauf geringer Rollwiderstand abrieb- und reißfest hohe Stoßfestigkeit sehr beständig gegen viele aggressive Medien <p>Guss-Polyurethan Felge Gusseisen lackiert → Seite 247</p>	<p>Zwei Schrägrollenlager lebensdauerdicht, Gabelkopf geschmiedet, sehr starker Zentralbolzen, Mutter durch gehärtete Madenschraube gesichert</p> <p>→ Seite 26</p>	<p>AUSWAHLHILFE:</p> <table border="0"> <tr> <td>leicht lenkend</td> <td>+</td> <td>+</td> <td>+</td> </tr> <tr> <td>verschleißarm</td> <td>+</td> <td>+</td> <td>+</td> </tr> <tr> <td>stoßfest</td> <td>+</td> <td>+</td> <td>+</td> </tr> <tr> <td>bodenschonend</td> <td>+</td> <td>+</td> <td>+</td> </tr> <tr> <td>witterungsbeständig</td> <td>+</td> <td>+</td> <td>+</td> </tr> </table>	leicht lenkend	+	+	+	verschleißarm	+	+	+	stoßfest	+	+	+	bodenschonend	+	+	+	witterungsbeständig	+	+	+
leicht lenkend	+	+	+																			
verschleißarm	+	+	+																			
stoßfest	+	+	+																			
bodenschonend	+	+	+																			
witterungsbeständig	+	+	+																			

Technische Details

ORDERNO (Artikel-nummer)	EH 303 SUTM
WDAB (Rad-Ø A x Breite B / mm)	300x76
LC (Tragkraft / kg)	3000
H (Bauhöhe H / mm)	422
TP (Plattengröße / mm)	178x153
HS (Lochabstand / mm)	127x102
HD (Loch-Ø / mm)	16.5
SR (Schwenkradius / mm)	222
WB (Radlager)	Schrägrollenlager